

## STEPS

(1) Hardware

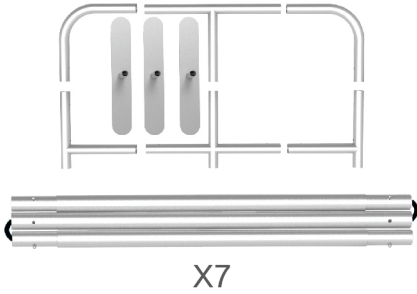

(2) Fabric banner



(3) Light Clips



**STEP 01** To connect the poles according to the labellings

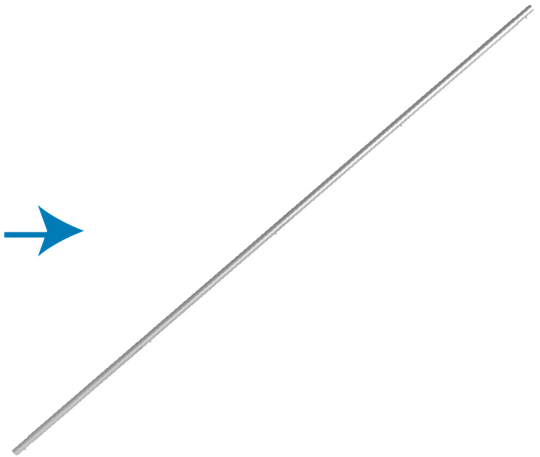
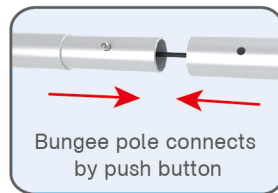

**STEP 02** To connect the long poles by corner pieces according to labellings and assemble middle upright pole in position.

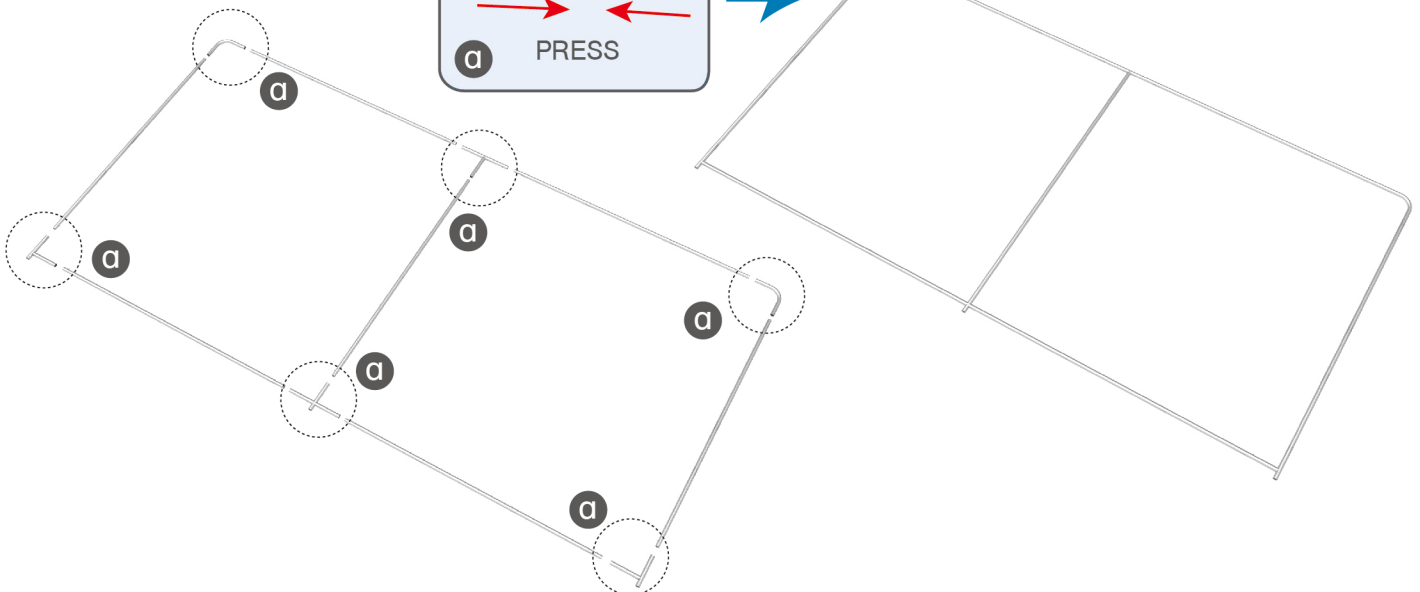
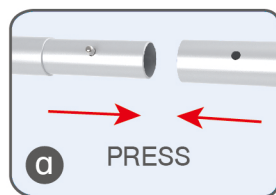

## STEPS

**STEP 03** To slide the fabric banner on the frame from top and zip up at bottom

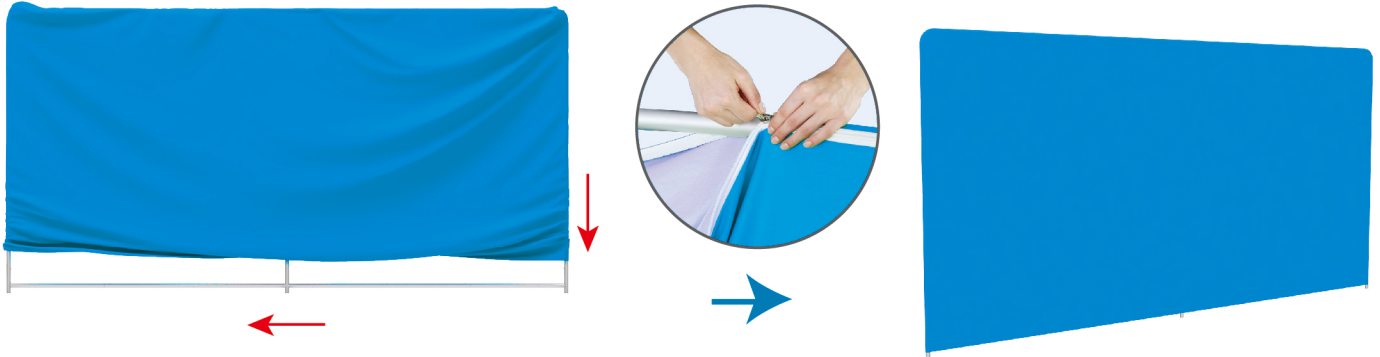

**STEP 04** To assemble the stand feet in position

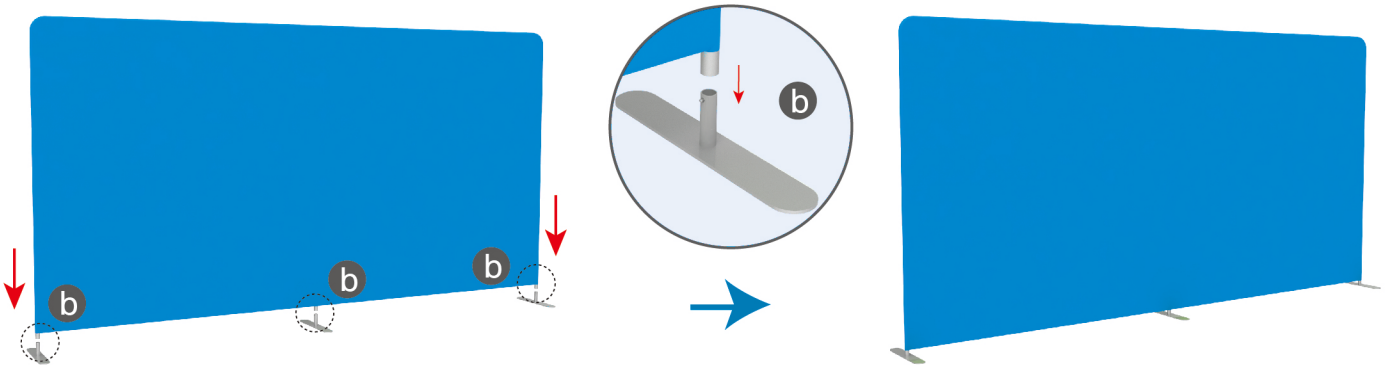

**STEP 05** To install the light clip at top of the banner stand and slide the light in position then adjust the light angle. **\*\*\*LED Lights are optional\*\*\***

