

★ One Tool (Hex Wrench) 

STEPS

(1) Snap Tubes

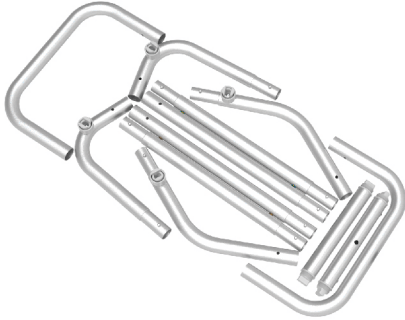

(2) Printed fabric banner



(3) Brochure rack x 2 / Screws x 4
Tablet PC holder x 1

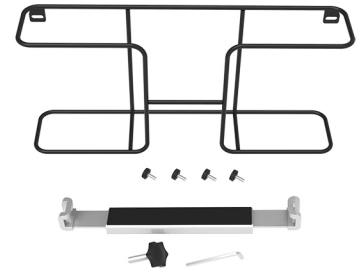

STEP 01

To Connect the tubes according to the labellings

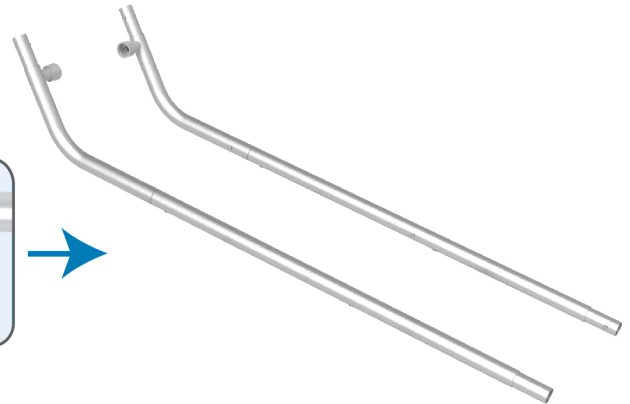
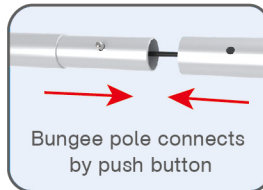

STEP 02

To connect 2 long side tubes by the corner pieces

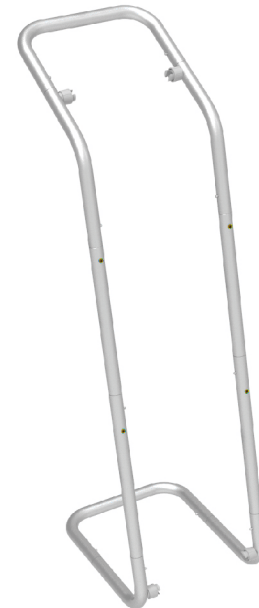
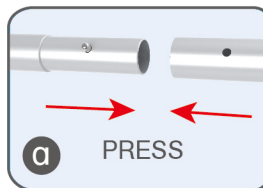

STEPS

STEP 03

To install the cross bar according to labellings

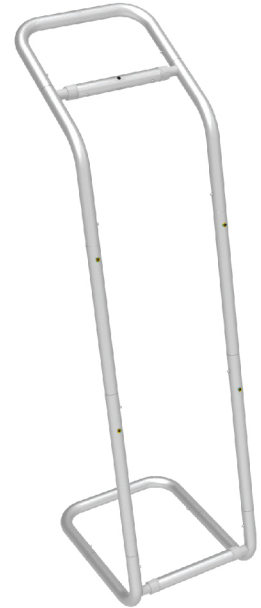
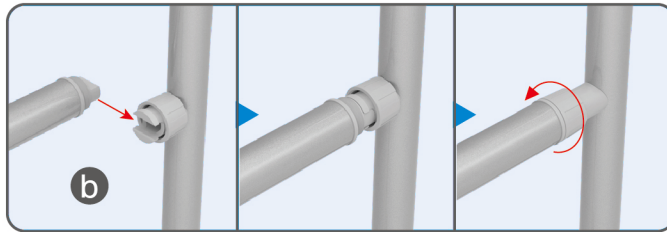
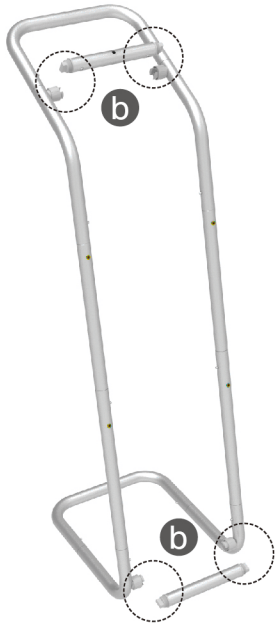

STEP 04

To wrap the fabric from top to the middle of frame, then put the iPad in the holder and adjust the holder to right size and lock it by Allen Key Afterwards, install the set to the display stand.

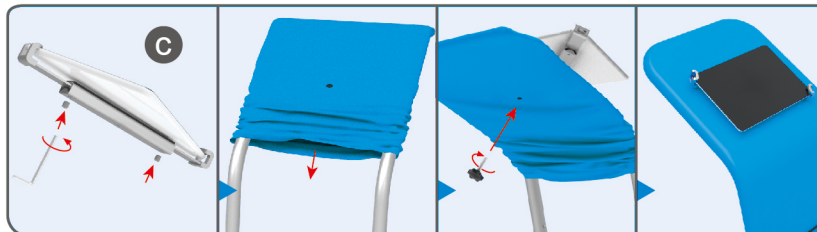

STEPS

STEP 05

To pull the fabric banner to bottom and zip up.



STEP 06

To Install 2 racks by screws in position

