

★ One Tool (Hex Wrench) 

## STEPS

### (1) Hardware

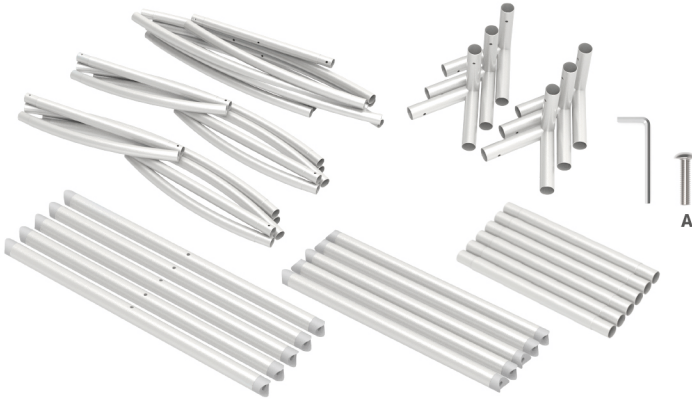

### (2) Printed Graphic Fabric Banner (Optional)

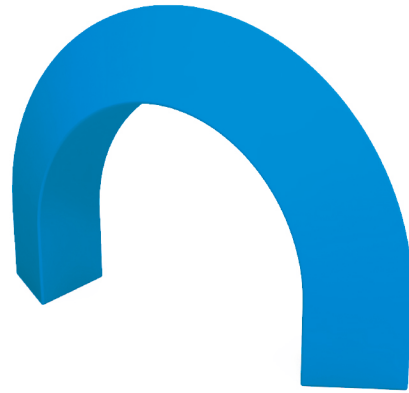

### STEP 01

Connect to make long poles according to labelings.

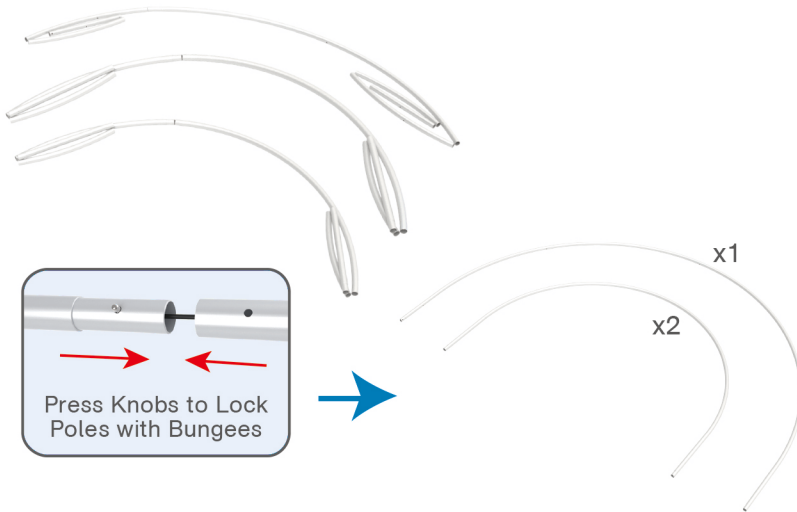

### STEP 02

Connect long poles with corner poles according to labelings.

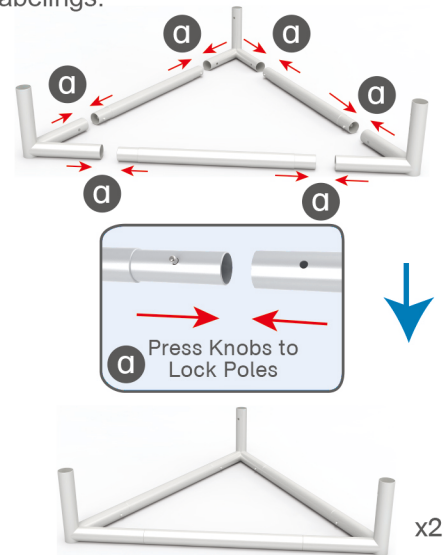

### STEP 03

Connect support poles onto frame.

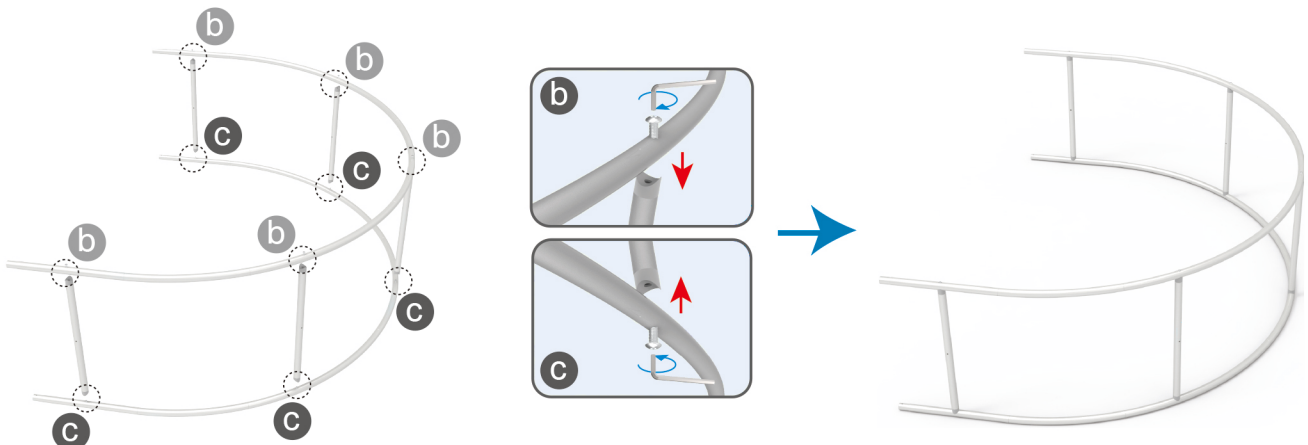

## STEPS

### STEP 04

Connect support poles onto frame.

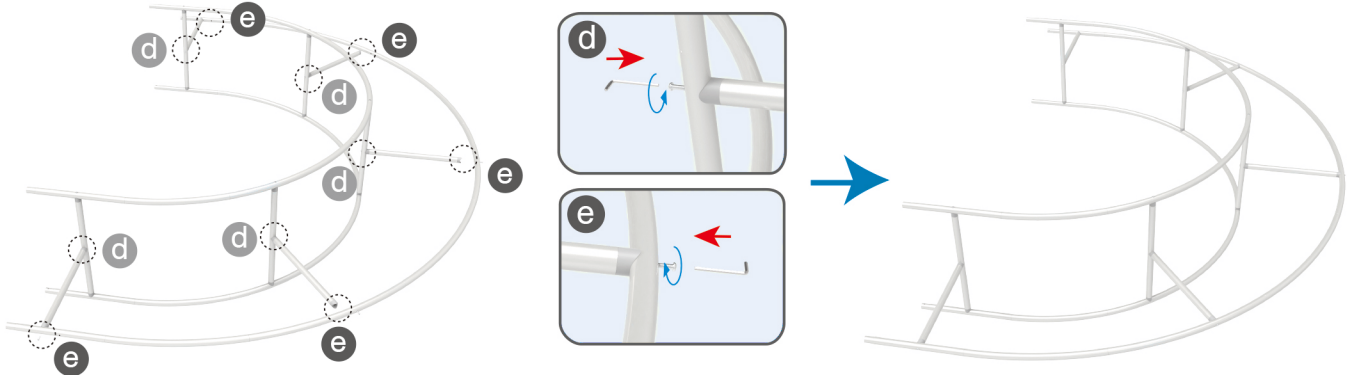

### STEP 05

Interconnect frames according to labelings.

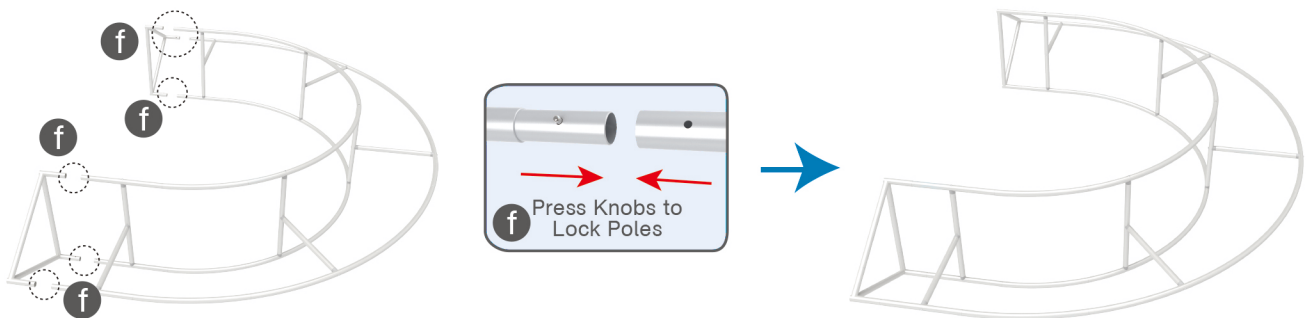

### STEP 06

Slide fabric banner on frame from bottom and zip up at top.

